

Production and Optimization of Bio-Oil from Municipal Wastewater Sludge by Thermal and Catalytic Pyrolysis Process

Manouchehr Haghighat , Nasrollah Majidian , Ahmad Hallajisani * ,
Mohammad Samipourgiri

1. Department of Chemical Engineering, Faculty of Engineering, North Tehran branch, Islamic Azad University, Tehran, Iran. E-mail: haghghat.man@gmail.com
2. Department of Chemical Engineering, Faculty of Engineering, North Tehran branch, Islamic Azad University, Tehran, Iran. E-mail: n_majidian@iau-tnb.ac.ir
3. Biofuel Research Labotary, Caspian Faculty of Engineering, College of Engineering, University of Tehran, Rezvanshar, Guilan, Iran. E-mail: hallaj@ut.ac.ir
4. Department of Chemical Engineering, Faculty of Engineering, North Tehran branch, Islamic Azad University, Tehran, Iran. E-mail: m_samipoor@iau-tnb.ac.ir

ARTICLE INFO	ABSTRACT
<p>Article History: Received: 25 April 2023 Revised: 24 June 2023 Accepted: 27 June 2023</p> <p>Article type: Research</p> <p>Keywords: Sewage Sludge, Catalytic Pyrolysis, Heat Value, Bio-Oil, Production Yield, Biomass</p>	<p>Limited resources and problems caused by fossil fuels consumption, have led researchers to pay attention to reproducible resources. In this study thermal and catalytic pyrolysis process were used to produce bio-oil from sewage sludge. In thermal pyrolysis, the effect of temperature, the heating rate and gas flow rate was investigated and optimum conditions for production of maximum amount of bio-oil with a production yield of 34.7% were determined equal to temperature 525 °C, heating rate of 20 °C/min and gas flow of 0.5 L/min. To improve the quality of bio-oil and reduce the number of oxygenated compounds, four catalysts HZSM-5 (SAR=40), Co/HZSM-5, Ni/HZSM-5 and Mo/HZSM-5 with weight ratios of 1:5 and 1:10 were used. Bio-oil produced by Mo/HZSM-5 catalyst with weight ratio of 1:5 and with factor groups of alkane/alkenes 27.72%, aromatic compounds 6.25 %, oxygenated compounds 5.82%, phenolic compounds 10.75% and high heat value 39.44 MJ/kg. Although the heating value of bio-oil produced from the catalytic pyrolysis of sewage sludge is lower than gasoline and bio-diesel, it is expected that by improving the quality of bio-oil, it will be used instead of fossil fuel in the future.</p>

Introduction

The world's population will reach 9.1 billion by 2040 [1]. This trend exacerbates the challenges of increasing demand for water, energy, increasing the production of municipal and industrial waste and wastewater. Since only 0.4% of the available water on this planet is available as fresh water [2], reducing of available water, increases the need for wastewater treatment. Sewage sludge is a byproduct of wastewater treatment and its production rate is 0.1-30.8 kg per person per year, with annual production of 10.13 million tons in Europe and more than 25 million in China [3].

Municipal wastewater purification is carried out in three stages: primary pretreatment, primary treatment and secondary treatment. In pretreatment, the raw inlet raw sludge is passed

* Corresponding Author: A. Hallajisani (E-mail address: hallaj@ut.ac.ir)



through the bar screens to remove large pieces and in the sand channel the grains, sand, and rocks are deposited at the bottom of the channel for disposal, and most of the suspended organic matter remains in the water column. In the primary treatment using microbes in aerobic bioreactors, the organic matter is stabilized and non-colloidal solids are removed [4, 5] which water in that reaches 95% [6]. Sludge obtained from secondary treatment by thickening, stabilization/styling and dewatering leads to moisture content of about 73-84% [7]. Sewage sludge is a complex heterogeneous mixture of microorganisms, more undigested organic matter including proteins (24-42%), fats (1-14%), carbohydrates (7-18%) [8-17]. The high heat value of undigested and digested dried sewage sludge was 23 MJ/kg [18] and 8.5-17 MJ/kg, respectively.

Methods of converting biomass to energy in thermochemical form include direct combustion, pyrolysis, gasification and liquefaction hydrothermal. The combustion process is carried out in an oxygen-rich atmosphere, gasification in an oxygen-diluted atmosphere, and liquefaction in an oxygen-free atmosphere. The disadvantages of combustion, gasification and liquefaction hydrothermal processes are low energy production efficiency, improper operating conditions and environmental pollution [19]. But pyrolysis is the best method due to low cost, low environmental pollution, easier operating conditions, high efficiency and the possibility of optimizing the obtained products [20-22].

Pyrolysis is a thermochemical collapse in the absence of oxygen [23-25]. Process products include bio-char, gas and bio-oil that the characteristics of each product depend on the operating factors of pyrolysis such as temperature, residence time, heating rate, composition of components, particle size, solid feed rate and catalyst [26-30]. High heating rates increase the possibility of biomass degradation into gas compounds and prevent the re-polymerization of vapors even at low temperatures, which will increase bio-oil production [31]. Due to the decrease in bio-oil production by increasing secondary reactions, by minimizing these reactions, the highest amount of bio-oil produced in the shortest residence time is achieved [32-37]. The most obtained bio-oil product is about 450- 550 °C [8, 29, 32, 35, 36, 38]. The highest amount of bio-char production is produced at lower temperatures and shorter vapor residence times, but the highest amount of gas is produced at high temperatures and longer residence times.

Bio-oil produced from thermal pyrolysis has high viscosity, high water and oxygen content, low HHV and high acidity [39, 40] which is not suitable as fuel and requires quality improvement, which is usually done by adding catalysts [39]. Zeolite-based catalysts are common catalysts, because they reduce the number of oxygenated compounds and increase aromatic hydrocarbons [41]. The pitted building of zeolite catalysts, after acidification, affects the aromatic process including dewatering, decarbonylation, decarboxylation and oligomerization. Optimization of ZSM-5 zeolites with ions that the noble transition metals supported alumina such as Pt [42], Ni [43], Ce [44], NiCe [45, 46], MgCe [44, 46] and CoMo [43] and the creation of acidic strong points, polycyclic aromatic hydrocarbons are converted into monocyclic aromatics, increasing the quality of bio-oil by catalytic deoxygenation and improve the quality of bio-oil.

Optimization of oxygen and nitrogen-rich bio-oils, such as those derived from sewage sludge, was not performed. In particular, no studies were found on the optimization of a bio-oil product derived from sewage sludge and the degree of deoxygenation and denitrogenation of bio-oil when Ni/HZSM-5 was used to catalytic optimization [25, 47-49] observed that in pretreatment of sludge by sonication, it is possible to process fats available to *L.starkeyi* (a yeast) containing approximately 70% dry matter. In addition, the best results were obtained by ultrasonic pretreatment compared to alkaline/acidic pyrolysis or thermal purification. One research shown that carbonyl compounds can be activated even at room temperature simply on

a 1% of Pd/C catalyst is hydrogenated with sufficient time (16 hours) [50, 51]. Rover MR et al. (2015) proposed model with platinum and nickel catalysts for hydrogenation of phenol in the middle aqueous liquid has just been released [20]. The research conducted by Arazo et al. (2017) with the aim of determining the effect of temperature, ethanol to sewage sludge ratio, reduction of reaction time on bio-oil product, degree of deoxygenation and denitrogenation in optimization of pyrolysis-produced oil with Ni-HZSM-5 catalyst showed that with increasing temperature, the removal rate of nitrogen and oxygen increases, but the amount of product production decreases. The optimum process conditions at 258.5 °C, ethanol to biomass ratio of 2.5, reaction time 2.23 h, yield of the obtained product 67.2%, the degree of denitrogenation and deoxygenation were 20.4% and 33.6%, respectively. Zeban Sha et al. (2020) with the aim of improving the quality of bio-oil, used dried sewage sludge with edible oil wastes in the range of 25-650 °C as feedstock in the pyrolysis process and reported the chemical properties of its products is good in comparison with commercial diesel S-10. Vincent et al. (2020) results of temperature effect in the range of 300-700 °C and zeolite-Y catalyst on the yield and composition of bio-oil produced from catalytic pyrolysis with yield of 20.9%, and non-catalytic 18.2 wt% reported the presence of 20-50 wt% nitrogenous compounds, 18-28 wt% mono-aromatic compounds, respectively.

In previous researches, the process of bio-oil production from sewage sludge with pyrolysis, generally temperature variable as the most important factor has been investigated. However, in this study, aspects of bio-oil production from sewage sludge using pyrolysis process including determination of quantitative and qualitative characteristics of feed and product obtained, economic and environmental aspects of produced bio-oil, conditions and uses of it, have been investigated and analyzed. In this study, simultaneously producing and optimizing bio-oil from municipal sewage sludge using thermal and catalytic pyrolysis has been done in series and its terms of use have been expressed.

Materials and Methods

Materials

Process input feed is secondary sludge of Shahryar (a city in Tehran province in central Iran) municipal sewage sludge treatment plant by sequence batch reactors (SBR). Approximate analysis and HHV of sewage sludge are given in Table 1. Nitrogen as carrier gas and dichloromethane (CH₂Cl₂) (Merck Company with 98% purity) were used as solvent for washing. Catalysts used include zeolite (HZSM-5), zeolite-based nickel (Ni/HZSM-5), zeolite-based cobalt (Co/HZSM-5) and zeolite-based molybdenum (Mo/HZSM-5) with ratio specification of SiO₂/Al₂O₃ equals 40, with a specific surface area of 370 m²/g, average pore size was 5.5 Å and crystallite was 98%. The loading level of metals is 5%. Catalyst characteristics tests were performed in Bim Gostar Taban laboratory. These catalysts were constructed using raw materials including nickel nitrate salts, cobalt nitrate, ammonium heptamolybdate and zeolite HZSM-5 by wet inoculation method to add these salts to HZSM-5 zeolite base in the catalyst laboratory of Arak University [52]. To achieve uniform distribution of metal on the base, the solutions were continuously and uniformly stirred at 400 rpm at 25 °C for 4 hours. Then, samples at 80 °C for 18 hours in an oven dried and in a furnace with 3 °C/min heating rate for 3 hours calcinated. The resulting powder was with used a hydraulic press equipment under 60 bar pressure, the crushed particles were separated in the range of 40-60 meshes (250-420 μm).

Table 1. Elemental Analysis and high heat values of sewage sludge and Bio-Oil Thermal Pyrolysis

Component	Sewage sludge (wt%)	Bio-oil (wt%)
C	28.8	62.6
H	4.4	8.4
N	4.5	5.5
O ^a	33.6	22.7
S	1.5	0.7
Moisture	6.3	-
Volatile	66.3	-
Ash	27.2	-
Fixed carbon ^b	0.2	-
HHV (MJ/Kg)	10.22	-
RE (%)		185.71

$$^a\%O=100-C-H-N-S$$

$$^b\text{Fixed carbon}=100-\text{volatiles}-\text{moisture}-\text{ash}$$

Devices & Equipment

The Laboratory Unit (Fig. 1) consists of three parts including, pyrolysis reactor, reformer and an electric heater. A condenser is used to cool and condense of gas products produced by pyrolysis process.

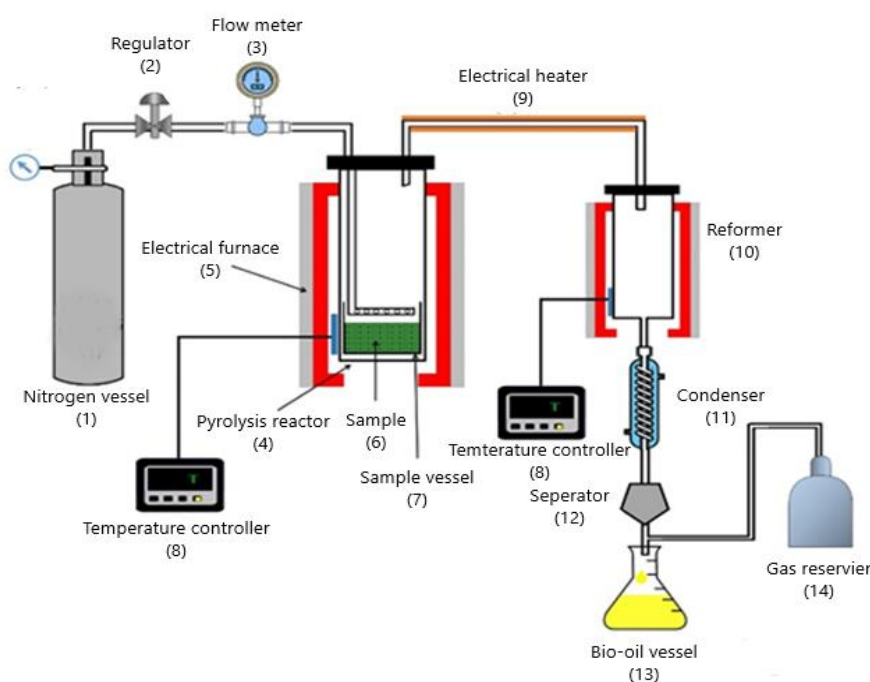
**Fig.1.** Process design of laboratory unit of bio-oil production research

Experiments

Thermal pyrolysis

First of all, the 20 g of sewage sludge was put in the reactor and its lid was closed. Then, by nitrogen gas with a flow of 100 ml/min for half an hour, the oxygen inside the reactor was discharged. According to Table 2, which is based on the design of the experiment with Design Expert 13 software, the temperature of the reactor, in accordance with the corresponding heating rate, increases constantly to reach the desired temperature. The gas obtained from the

pyrolysis of sewage sludge passes through a condenser. Vapors turn into liquid (bio-oil) and incompressible gases are released. At this stage, the temperature of the reactor is kept constant for 30 min, until the thermal decomposition of the sample is completed. Then, the device is turned off and given enough time for the reactor to reach ambient temperature, after opening the door of the device, the remaining solid is removed from the reactor and weighed. The

Table 2. Selected points performing tests

Run	T (°C)	Q (L/min)	H (°C/min)	Bio-Oil (wt%)	Bio-Char (wt%)	Gas (wt%)
1	400	0.2	10	27.87	54.21	17.92
2	600	0.2	10	31.36	50.6	18.04
3	400	0.8	10	28.65	53.74	17.61
4	600	0.8	10	32.17	50.06	17.77
5	400	0.2	20	29.27	52.97	17.76
6	600	0.2	20	32.53	49.66	17.81
7	400	0.8	20	30.05	52.07	17.88
8	600	0.8	20	33.18	49.06	17.76
9	400	0.5	15	28.94	53.77	17.29
10	600	0.5	15	32.41	50.18	17.41
11	500	0.2	15	33.97	48.58	17.45
12	500	0.8	15	34.76	48.00	17.24
13	500	0.5	10	33.32	49.56	17.12
14	500	0.5	20	34.09	49.39	16.52
15	500	0.5	15	34.45	49.46	16.09
16	500	0.5	15	34.51	48.05	17.44
17	500	0.5	15	34.39	48.80	16.81
18	500	0.5	15	34.46	48.88	16.66
19	500	0.5	15	34.42	48.25	17.33
20	500	0.5	15	34.46	48.80	16.74

resulting bio-oil are collected and weighed, then the yield of bio-oil, bio-char and gas produced using the Eqs. 1, 2 and 3 are calculated [53].

$$\text{Bio - oil yield (wt\%)} = \frac{\text{mass of bio - oil (g)}}{\text{mass of feed (g)}} \times 100 \quad (1)$$

$$\text{Bio - char yield (wt\%)} = \frac{\text{mass of bio - char (g)}}{\text{mass of feed (g)}} \times 100 \quad (2)$$

$$\text{gas (wt\%)} = 100\% - [\text{bio - oil yield (wt\%)} + (\text{bio - char yield (wt\%)})] \quad (3)$$

Catalytic Pyrolysis

The catalytic pyrolysis testing process includes equipment, raw materials, and test methods such as thermal pyrolysis testing. The experiments were performed at a temperature 525 °C, heating rate of 20 °C/min and gas flow of 0.5 L/min. Except one of the four catalysts prepared in the quartz tube is placed as a thin layer on the refractory cotton and is cylindrically inserted into the net and then the chamber is placed in the reformer. According to the diameter of the quartz tube, the thickness of the catalyst layer and the volumetric flow rate of nitrogen gas, the residence time of volatile substances in the catalyst layer is less than a second. Eight experiments are carried out with 4 types of catalysts with the same operating conditions. For each catalyst, 2 tests with catalyst-to-feed weight ratios of 1:10 and 1:5 would be done. In calculating the gas yield, the mass of carbon deposited on the catalyst is ignored. In order to

increase the accuracy and reliability of results, some experiments were repeated three times and the mean of close results was recorded.

Analysis

Approximate analysis was performed to determine the properties of sewage sludge as feed (Table 1). Elemental analysis was carried out with the TruSpec equipment LECO company made in USA. High heat value is calculated by using the equation Dulang (Eq. 4) [54] and the energy recovery with the Eq. 5 [55]:

$$HHV \left(\frac{MJ}{kg} \right) = 0.3383 \times C(\text{wt}\%) + 1.442 \times \left[H(\text{wt}\%) - \frac{O(\text{wt}\%)}{8} \right] \times 100\% \quad (4)$$

$$\text{Energy recovery}(ER) = \frac{HHV_{\text{bio-oil}} \times m_{\text{bio-oil}}}{HHV_{\text{bio-mass}} \times m_{\text{bio-mass}}} \times 100 \quad (5)$$

Thermal gravimetric analysis (TGA) was carried out with the Q600 device of TA company made in USA (Fig. 2). Mass GC-MS test was performed by GC7890-MS5975 device, Agilent Company of USA, HP-5 column type to determine the percentage of constituents, identify the type and amount of organic bio-oil composition obtained [56]. Helium was used as the carrier gas. First, the temperature was kept at 40° C for 1 minute, then was raised to 300 °C and kept for 5 minutes. Dichloromethane was also used as a solvent. SEM test by using sweeping electronic microscope (SEM) (MIRA II Model, FESEM detector SAMX, TESCAN Company, France), XRD test in order to determine crystalline structure by model PW1730 Philips company, Netherlands, FTIR test for identification. The functional groups in organic molecules have been performed on catalysts by AVATAR model device of THERMO Company and BET testing (BELSORP MINI II, BEL company, Japan).

Results and Discussions

Results of Experiments on Biomass

Three steps and their corresponding peaks can be seen in the TGA diagram (Fig. 2). The first step occurs in the temperature range of 40-75 °C, which indicates the evaporation of moisture. The second peak at the temperature of 304.64 °C is related to cellulose compounds. The third peak at 500 °C represents the evaporation of lignin compounds in sewage sludge.

Results of Experiments on Catalysts

The results of experiments performed on HZSM-5 (SAR=40), Co/HZSM-5, Ni/HZSM-5 and Mo/HZSM-5 catalyst pyrolysis tests are as follows:

XRD Test Results

The study of crystalline structure of catalysts shows that metal based on zeolite HZSM-5 shows that by showing the metals on the zeolite base, the regular crystal structure in zeolite is preserved without changing (Fig. 3). The main peak for zeolite-based nickel, cobalt and molybdenum metal catalysts is also located in the same region. There is a slight difference in some small peaks, which indicates a slight change in the crystal structure of the catalysts due to the integration of the metal compound with the zeolite base. Research conducted by Ge et

al. (2019) for five catalysts HZSM-5, Cu (5%)/HZSM-5, Cu (10%)/HZSM-5, Co (5%)/HZSM-5 and Co (10%)/HZSM-5 also have the same slender peak for all five-power catalytic [57]. Therefore, it can be concluded that the distribution of metal catalysts on zeolite base is completely uniform and the catalysts are very suitable and also, the angle of the peaks in terms of width and sharpness of the edge represents the same size of the catalysts in all four samples.

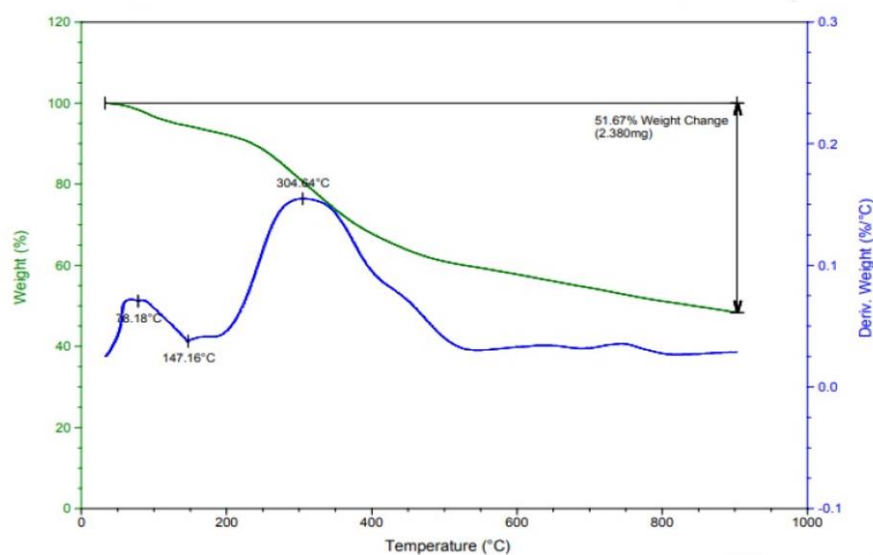

Fig. 2. Thermal gravimetry and differential gravimetry analysis of sewage sludge

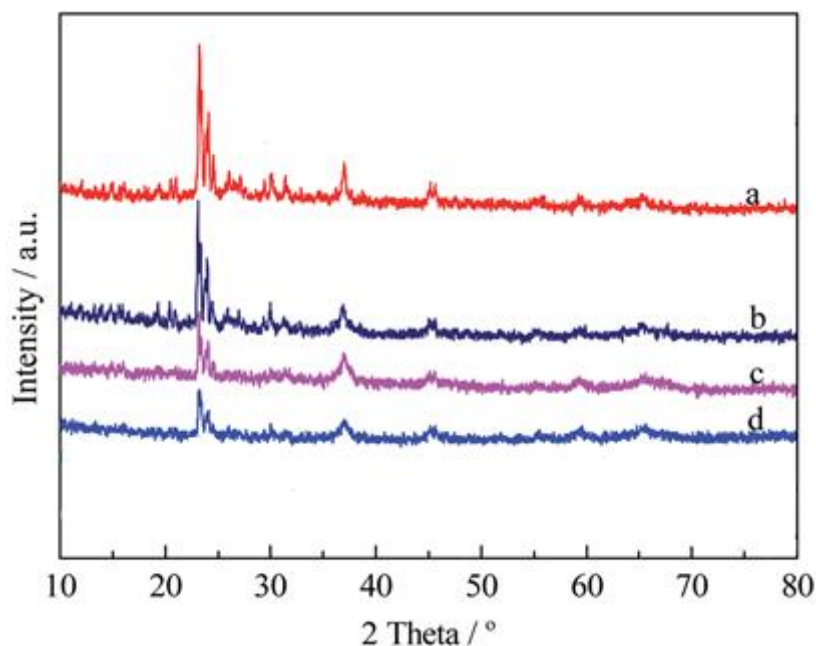

Fig. 3. X-ray diffraction pattern for catalysts, a) HZSM-5, b) Ni (5%)/HZSM-5, c) Mo (5%)/HZSM-5, and d) Co (5%)/HZSM-5

SEM Test Results

The Fig. 4a of the HZSM-5 catalyst shows smooth, multi-dimensional particles with dimensions less than 5 μ m. The Figs. 4b, 3c and 3d that were harvested from Co/HZSM-5, Ni/HZSM-5 and Mo/HZSM-5 catalysts, respectively, show small particles of metal catalysts that are barely distinguishable between large zeolite particles. But the dispersion and uniform distribution of metal catalyst particles among zeolite particles is quite evident. The morphology of metal catalyst particles of nickel, cobalt, molybdenum on the zeolite base is almost identical and cannot be distinguished. Similar research results conducted by Vichaphund et al. (2013) on the catalysts of HZSM-5, Ni/HZSM-5 and Co/HZSM-5 also show exactly the same results [58].

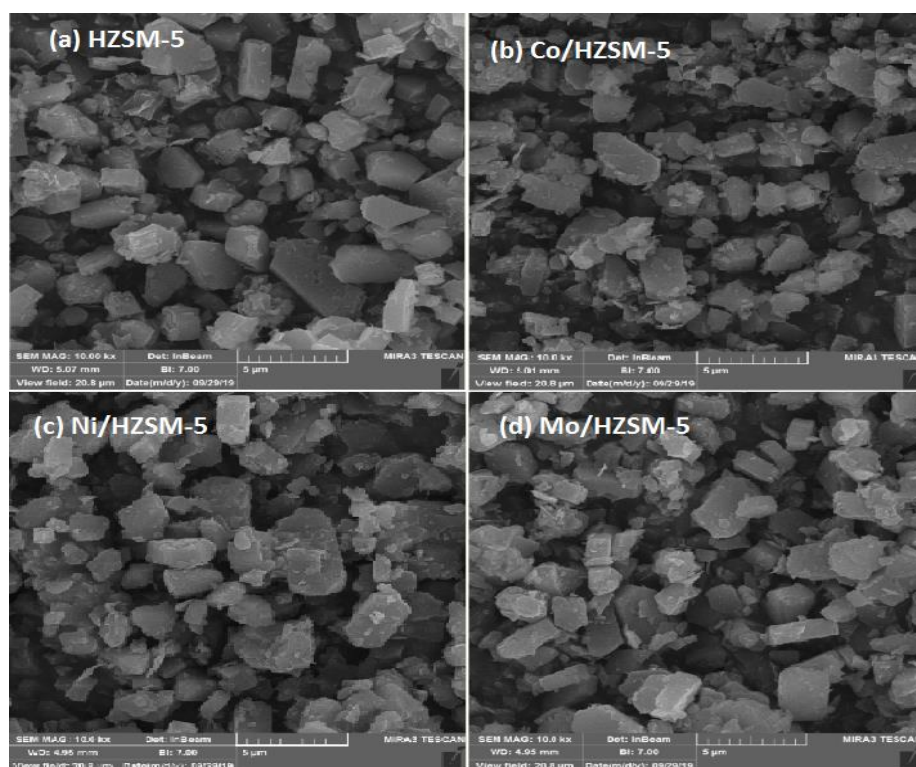

Fig. 4. Images of catalysts

FTIR Test Results

The results of FTIR zeolite catalyst were shown in the Fig. 5. The first and second peaks at 454 and 548 cm^{-1} related to SiO_4 molecular oscillation energy and the next three peaks at 796 , 1089 and 1223 cm^{-1} , respectively, show the tensile energy of Si-O-Al bond structure, respectively that all of them represent complete and appropriate synthesis of produced zeolite. The sixth peak at 1630 cm^{-1} is related to the dual carbon bond (C=C) and the seventh peak at 3426 cm^{-1} related to the tensile energy of the O-H bond related to the absorbed water [59]. There is not much change in its structure and the initial structure of zeolite has remained almost constant. Experiments performed on these catalysts by Ali et al (2003) in peaks of 450 , 542 , 791 , 1080 , 1219 , 1636 and 3170 cm^{-1} were also show similar results [60].

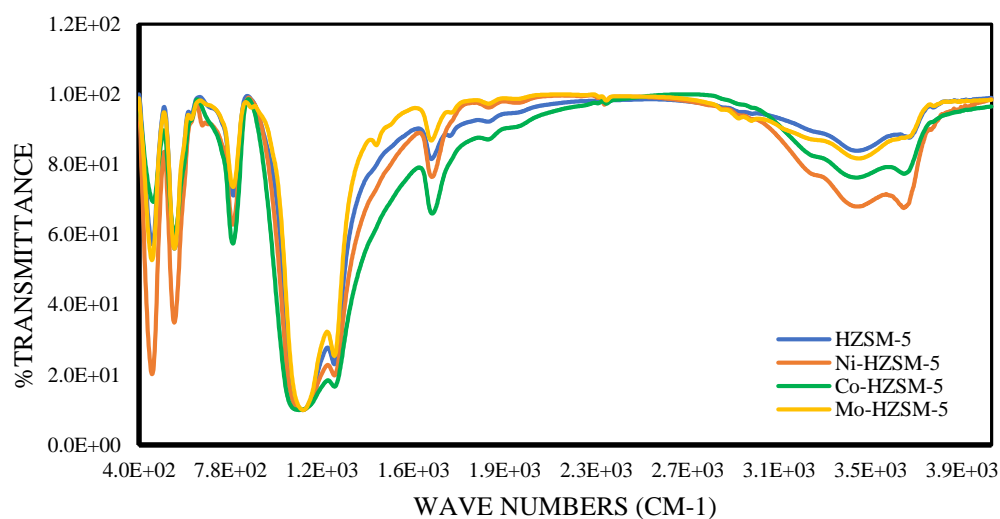

Fig. 5. Curves of FT-IR experiments on catalysts

BET Test Results

Measurement of specific surface of (S_{BET}), mean volume of pores per unit mass (V_p) and mean of diameter of pores of catalysts used in this study in BET experiment presented in Table 3, shows that some metal catalyst particles placed on pores on zeolite base and penetration of some of them have led to the filling of these pores, reducing the specific level and volume of the base pores. Instead, due to the larger average diameter of metal catalyst pores, the mean diameter of Co/HZSM-5, Ni/HZSM-5 and Mo/HZSM-5 catalysts increased compared to the HZSM-5 base. The results of the study conducted by He D et al. (2017) on HZSM-5, Co/HZSM-5 catalysts confirm this phenomenon [61].

Table 3. Results of BET Catalysts Tests

Catalysts	APD (nm)	S_p (m^2/g)	V_p (cm^3/g)
HZSM-5	3.9659	51.197	0.050761
Co/HZSM-5	13.114	7.601	0.02492
Ni/HZSM-5	23.494	9.0276	0.053024
Mo/HZSM-5	6.5197	36.244	0.059076

Thermal Pyrolysis

According to Table 2, which is based on the design of the experiment with Design Expert 13 software, the temperature of the reactor, in accordance with the corresponding heating rate, increases constantly to reach the desired temperature. Result of researches show that sewage sludge samples with lower the ash content and more than volatile materials, better than for liquid pyrolysis products [18]. Based on the results of GC-MS analysis, the values of important functional groups obtained from bio-oil from thermal pyrolysis have been sorted in Table 4 which include alkanes/alkenes, aromatic compounds, oxygenated, nitrogenous compounds and phenolic compounds.

Table 4. Percentage of bio-oil compounds in GC-MS analysis

No	Formula	Component	Wt. (%)
Acids			
1	$C_{16}H_{32}O_2$	n-Hexadecanoic acid	2.8
2	$C_{18}H_{36}O_2$	Octadecanoic acid	0.4
Alcohols			
3	$C_{12}H_{26}O$	1-Dodecanol	1.5
4	$C_{16}H_{34}O$	1-Hexadecanol	1.4
5	$C_{14}H_{30}O$	2-Hexyl-1-octanol	0.8
Aldehydes			
6	$C_{16}H_{30}O$	E-14-Hexadecanal	1.9
Alkanes			
7	$C_{13}H_{28}$	Tridecane	4.11
8	$C_{14}H_{30}$	Tetradecane	1.9
9	$C_{14}H_{30}$	Teridecane, 2-methyle-	0.7
10	$C_{15}H_{32}$	Pentadecane	4.5
11	$C_{19}H_{40}$	Tridecane, 7-hexyle	0.92
12	$C_{16}H_{34}$	Hexadecane	2.64
13	$C_{18}H_{38}$	Octadecane	0.75
14	$C_{19}H_{40}$	Nonadecane	0.57
Alkenes			
15	C_8H_8	Indene	1.98
16	C_9H_8	1-Dodecene	0.52
17	$C_{12}H_{24}$	1-Decene	1.32
18	$C_{10}H_{20}$	1-Tridecene	1.15
19	$C_{13}H_{26}$	Cis-2-Methyl-	2.07
20	$C_{19}H_{38}$	7-Octadecene	3.15



21	C ₁₆ H ₃₂	3-Hexadecene, Z	1.74
22	C ₁₄ H ₂₈	7-Tetradecene, Z	0.98
23	C ₁₈ H ₃₆	3-Octadecene, E	0.92
24	C ₂₀ H ₄₀	2-Methyl-7-nonadecene	2.21
25	C ₂₀ H ₄₀	9-Eicosene, E	1.35
Aromatics			
26	C ₇ H ₈	Toluene	1.31
27	C ₈ H ₁₀	Ethylbenzene	0.52
28	C ₉ H ₁₂	Benzene, 1-ethenyl-2-methyl-	0.95
Ester			
29	C ₂₄ H ₃₈ O ₄	di-n-octyl phthalate	0.96
Ketones			
30	C ₆ H ₁₀ O	3-penten-2-one 4-methyl-	1.12
31	C ₁₁ H ₈ O ₃	1-methyl 1-5-piperidin-1-yl- imidazolidin-1 4-dione	5.1
32	C ₉ H ₁₇ NO	4-piperidone 2 2 6 6- tetramethyl-	2.3
Nitrogenated			
33	C ₄ H ₅ N	Pyrrole	4.52
34	C ₉ H ₉ N	1H-indole	3.58
35	C ₈ H ₇ N	3-methyl-	3.12
36	C ₉ H ₉ N	enzyl nitrile	2.15
37	C ₁₆ H ₃₁ N	Benzenepropanenitrile	1.45
38	C ₁₇ H ₃₃ N	Hexadecanenitrile	0.96
39	C ₆ H ₉ N	Heptadecanenitrile	1.05
40	C ₆ H ₇ NO ₂	1H-Pyrrole, 2,4-dimethyle	0.85
41	C ₈ H ₈ O	3-Acetamidofuran	1.25
Phenols			
42	C ₆ H ₆ O	Phenol	4.45
43	C ₇ H ₈ O	Phenol, 2-methyl-	1.56
44	C ₇ H ₈ O	Phenol, 4-methyl-	7.58
45	C ₈ H ₁₀ O	Phenol, 4-ethyl-	3.25

The percentage of alkane/alkenes in fuel has the direct relation [62] and oxygenated compounds have the opposite ratio to its heat value [63]. High percentage of aromatic, nitrogenous and phenolic compounds cause more fuel pollution. If the content of aromatic compounds is less than 25%, it increases convention to some extent. However, if their amount is more than 25%, it will increase the pollution. Presence of phenolic compounds increases the oxidative stability of the fuel, but the existence of these three compounds is carcinogenic, in particular, nitrogenous compounds cause NO_x gases. So, although the bio-oil from thermal pyrolysis with the weight percentage of components of the functional groups of alkanes/alkenes 33.48%, aromatic compounds 2.78%, oxygenated compounds 18.93%, nitrogenous compounds 18.93% and phenolic compounds 16.84%, in terms of good heat value and low emissions, is a relatively suitable fuel. However, it needs optimization.

Modeling

Variance Test

Analysis of data integrity and the type of effect of the tested variable on the target variable (yield of oil-biomass) is used. Analysis of variance of yield of bio-oil has been performed using Design Expert 13 software and its results are shown in Table 5.

Table 5. Coefficients provided by the software

Term	Factor	P-value
Constant	-56.97604	<0.0001
T(°C)	0.386312	<0.0001
Q(L/min)	0.001446	<0.0001
H(°C/min)	0.386076	<0.0001
T*Q	-4.16667E-07	0.7880
T*H	-0.000155	0.1176
Q*H	-0.000013	0.6679
T ²	-0.000367	<0.0001
Q ²	2.32323E-07	0.7920
H ²	-0.005564	0.1017

The study shows that the software based on the data of the Table 5 has proposed a model based on quadratic, including line expressions, two interaction expressions. Two main criteria in the results provided by the software are P-value and correlation coefficient (R^2), which represent the accuracy, precision and efficiency of the models, respectively. The acceptable amount of P-value defined as pre assumption in software is $P < 0.05$, so presented model according to $P\text{-value} < 0.05$ and $R^2 = 0.9891$ is perfectly suitable.

Since the P-value of each term, represents the degree of importance of that term, terms with p-value of <0.0001 are more important than others. Therefore, TQ, TH, QH, Q^2 and H^2 sentences are more important, but the importance of T and H terms is more. The absolute value of the numbers located in the coefficient column in the Table 5 indicates the effect of the corresponding term on the model, and the positive sign of the coefficient represents the increasing effect and the negative sign represents the decreasing effect of the corresponding term on the target variable, therefore, temperature and heating rate variables have the greatest impact on the yield of bio-oil produced production.

The Overall Impact of Variables

The overall effect of variables on the yield of bio-oil production is shown in the Fig. 6. The lines represent the high and low confidence intervals of 95%. The nonlinear form is increased and decreases after reaching its maximum value from 466 °C to 625 °C. However, the yield of bio-oil in the test range is linearly enhanced by increasing the volumetric flow rate of the carrier gas and almost linearly by increasing the heating rate.

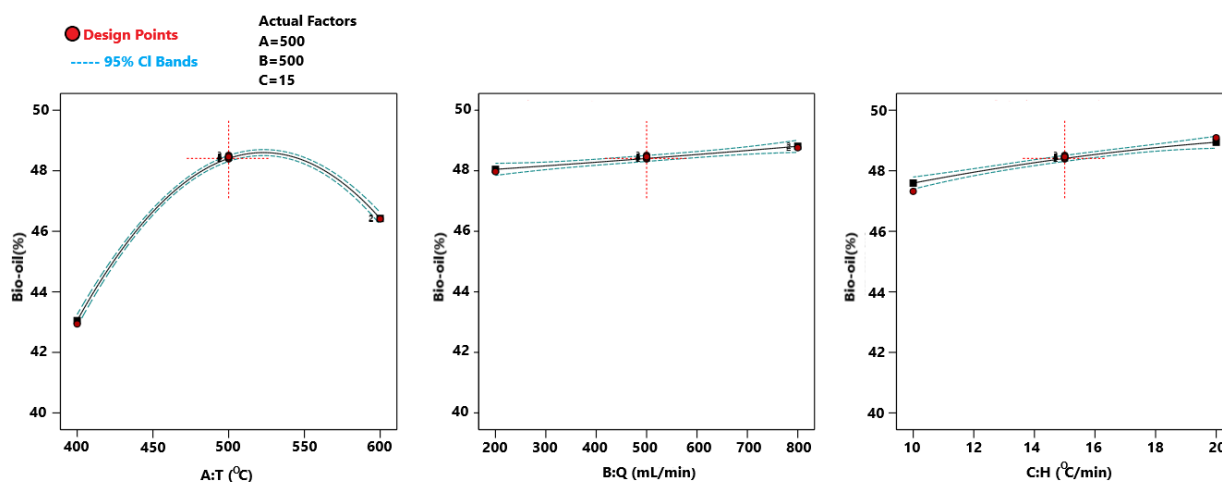

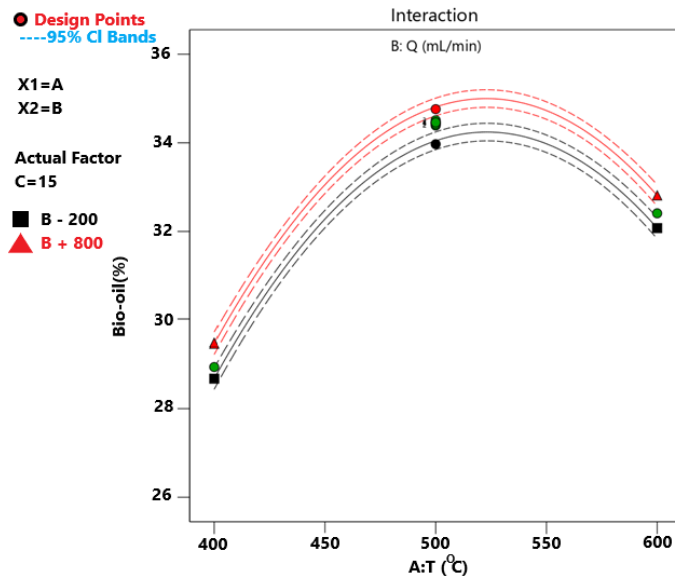

Fig. 6. The overall impact of effective variables on bio-oil production yield

Statistical Model

The equation of predicting the results of the bio-oil yield produced by the model presented by the software includes the Eq. 6 respectively.

$$\begin{aligned}
 BIO - OIL(Predict) &= -56.97604 + 0.386312(T) + 1.446E - 03(Q) \\
 &+ 0.386076(H) - 3.67E - 4(T^2)
 \end{aligned}
 \tag{6}$$

where T is accordance with $^{\circ}C$, Q with L/min and H with $^{\circ}C/min$.

In order to evaluate accuracy of efficiency of the proposed model, the comparison diagram of the predicted results by the model with the actual results corresponding to the Fig. 7 is presented. The results of the points in the form represent the appropriate matching of the predicted results with the actual data and the reliability of the results is acceptable.

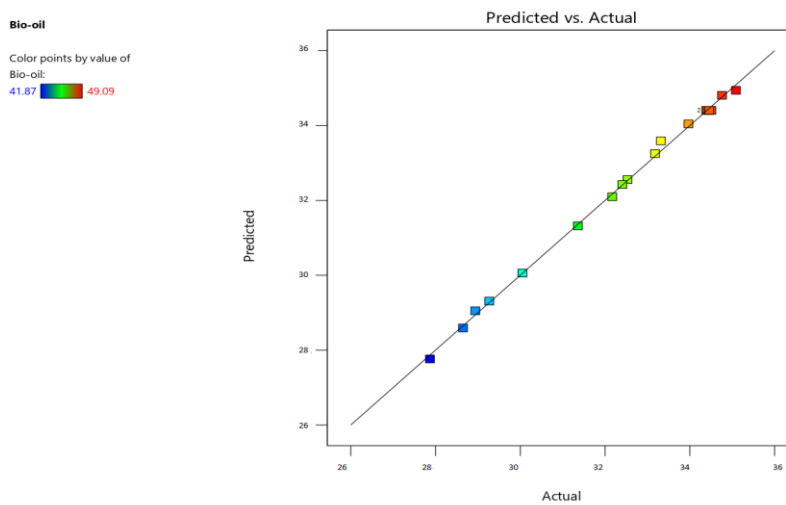

Fig. 7. Comparison of model prediction results with experimental bio-oil- produced results

Response Surface Diagrams

The Fig. 8 shows the highlighted level chart and the three-level Fig. 9, the regions with the red color represent the higher response level. In the 3D diagram of response surface can be observed that the increase in temperature increases the yield of bio-oil production first, and after reaching a maximum point, decreases with increasing temperature, and changes in the volumetric flow rate of the carrier gas and heating rate have little effect on this trend.

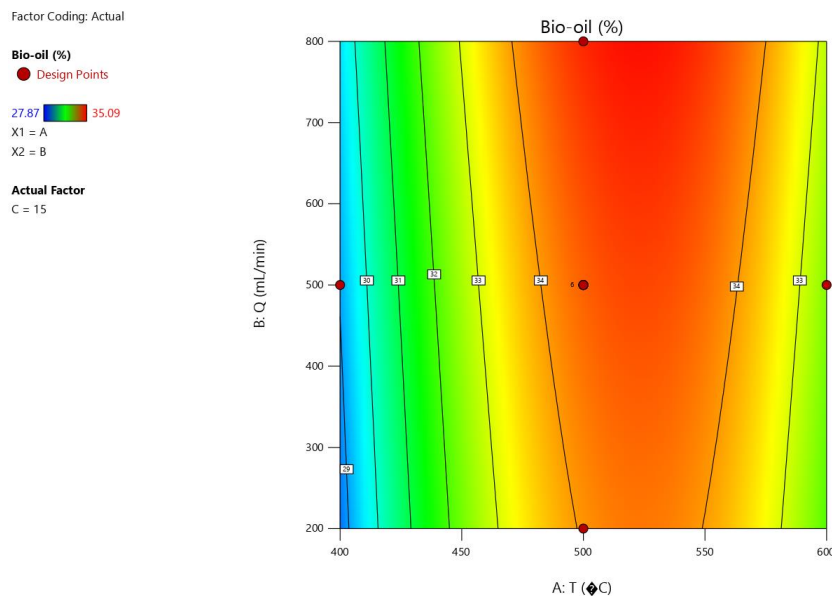

Fig. 8. Two-dimensional bio-oil response level diagram produced in terms of effective variables

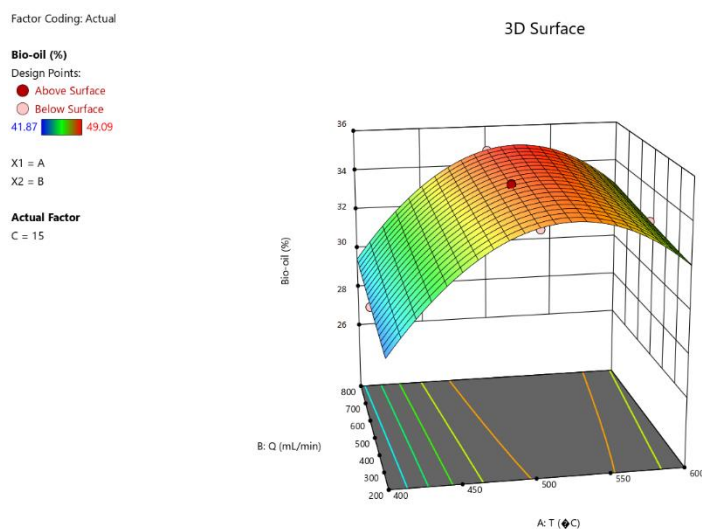

Fig. 9. 3D bio-oil response surface diagram produced in terms of effective variables

Optimization

By using of mathematical model and two and three-dimensional response surfaces, the effective variables affecting the production and yield of the produced bio-oil were investigated by examining the effective variables in the production and yield of the produced bio-oil from the sewage sludge of urban 525 °C, the flow rate of the gas carrying 0.5 L/min and the heating rate of 20 °C/min with yield of bio-oil production 32.84 wt%, which is the mathematical model. 34.77 wt% with a slight error of 5.87% predicts the precision, accuracy and efficiency of the model.

Catalytic Pyrolysis

The results of bio-oil yield are shown in [Table 6](#). The highest bio-oil yield produced using zeolite catalyst with a ratio of 1:10 is 18.51%, which is the best yield among these catalysts.

Table 6. Production yield of catalytic pyrolysis products of sewage sludge

Catalyst	Catalyst to Feed ratio (C/B)	Bio-oil (wt%)	Bio-char (wt%)	Gas (wt%)
HZSM-5	1:10	18.51	55.38	26.11
HZSM-5	1:5	16.94	55.41	27.65
Co/HZSM-5	1:10	16.24	55.65	28.11
Co/HZSM-5	1:5	15.73	55.73	28.54
Ni/HZSM-5	1:10	16.1	55.73	28.17
Ni/HZSM-5	1:5	13.96	54.92	31.12
Mo/HZSM-5	1:10	16.48	54.07	29.45
Mo/HZSM-5	1:5	15.85	55.31	28.84

[Table 7](#) the results of elemental analysis and [Table 8](#) show HHV and energy recovery of bio-oil samples produced from catalytic pyrolysis by Dulang equation.

Table 7. Results of elemental analysis of bio-oil samples produced from the catalytic pyrolysis of sewage sludge

Catalyst	C: B	C	H	N	Or	S
HZSM-5	1:10	67	9.6	6.1	16.5	0.8
HZSM-5	1:5	68.9	9.8	6.3	14.2	0.8
Co/HZSM-5	1:10	69.5	10.3	6.25	13.1	0.85
Co/HZSM-5	1:5	70.65	10.4	6.5	11.6	0.85
Ni/HZSM-5	1:10	70.08	11.05	6.22	11.8	0.85
Ni/HZSM-5	1:5	71.35	11.3	6.63	9.8	0.92
Mo/HZSM-5	1:10	70.96	11.2	6.52	10.4	0.92
Mo/HZSM-5	1:5	72.27	11.5	6.71	8.6	0.92

Table 8. High heat value and energies recovery of pyrolysis oil with different catalysts

Catalyst	C: B	HHV (MJ/kg)	ER (%)
HZSM-5	1:10	33.52	40.18
HZSM-5	1:5	34.86	41.78
Co/HZSM-5	1:10	35.98	43.13
Co/HZSM-5	1:5	36.78	44.09
Ni/HZSM-5	1:10	37.48	44.92
Ni/HZSM-5	1:5	38.63	40.30
Mo/HZSM-5	1:10	38.25	45.85
Mo/HZSM-5	1:5	39.44	47.27

Analysis of qualitative characteristics of bio-oil samples produced from catalytic pyrolysis using the results of GC-MS analysis presented in [Table 9](#) shows that the components of functional groups in bio-oil produced by catalytic pyrolysis include alkane/alkenes, aromatic compounds, oxygenated, nitrogenous compounds and phenolic compounds that the percentage of their components in [Table 10](#) is presented.

Table 9. Results of GC-Mass analysis of bio-oil samples obtained from catalytic pyrolysis of sewage sludge

Raw	Compound	Formula	With 1:5	From 1:10	Co/Z 1:5	Co/Z 1:10	Ni/Z 1:5	Ni/Z 1:10	Mon/Z 1:5	Mon/Z 1:10
1	Phenol	C ₆ H ₆ O	2.15	1.95	2.85	2.7	2.75	2.45	2.8	2.6
2	4-ethyl-phenol	C ₈ H ₁₀ O	1.75	1.85	2.1	1.75	1.7	1.6	1.7	1.6
3	2-methyl-phenol	C ₇ H ₈ O	0.9	0.8	1.2	1.1	1.15	1.1	1.35	1.25
4	4-methyl-phenol	C ₇ H ₈ O	3.2	3.0	3.7	3.53	3.55	3.35	3.6	3.4
5	Toluene	C ₇ H ₈	2.8	2.6	2.7	2.5	3.1	2.6	2.9	2.4
6	Ethylbenzene	C ₈ H ₁₀	1.1	0.9	1.05	0.85	1.24	0.9	1.1	0.8
7	Benzene, 1-ethenyl-2-methyl-	C ₉ H ₁₂	2.1	1.9	2.2	2.05	2.3	2.05	2.25	1.95
8	Pyrrrole	C ₅ H ₅ N	2.55	2.25	2.7	2.5	2.9	2.7	2.4	2.2
9	1H-indole 3-methyl	C ₉ H ₉ N	6.9	6.8	7.36	6.85	8.17	7.31	6.68	6.15
10	Benzyl nitrile	C ₈ H ₇ N	4.4	4.25	4.6	4.47	4.71	4.5	4.35	4.22
11	Benzenepropanenitrile	C ₉ H ₉ N	4.1	3.9	4.3	4.17	4.41	4.2	4.05	3.92
12	Hexadecane	C ₁₆ H ₃₄	2.7	2.6	2.85	2.8	2.95	2.9	2.8	2.75
13	Tridecane	C ₁₃ H ₂₈	4.2	4.05	4.35	4.3	4.55	4.5	4.45	4.35
14	Pentadecane	C ₁₅ H ₃₂	4.6	4.45	4.8	4.7	4.9	4.8	4.7	4.65
15	Tetradecane	C ₁₄ H ₃₀	2.0	1.9	2.1	2.1	2.3	2.15	2.1	2.05
16	Bicyclocra-1,3,5-triene	C ₈ H ₈	2.0	1.8	2.3	2.2	2.5	2.3	2.2	2.4
17	1-Dodecene	C ₁₂ H ₂₄	1.5	1.4	1.8	1.7	2.2	2.05	1.7	1.65
18	1-Decene	C ₁₀ H ₂₀	1.8	1.7	2.1	2.05	2.4	2.25	2.0	1.9
19	1-Tridecene	C ₁₃ H ₂₆	2.1	1.9	2.5	2.35	3.0	2.8	2.4	2.3
20	Cis-2-Methyl-7-Octadecene	C ₁₉ H ₃₈	3.2	3.15	3.3	3.26	3.4	3.33	3.27	3.24
21	2-Methyl-7-nonadecene	C ₂₀ H ₄₀	2.25	2.45	2.05	2.0	1.75	1.8	2.1	2.15
22	n-Hexadecenoic acid	C ₁₆ H ₃₂ Th e ₂	2.2	2.15	2.3	2.26	2.4	2.33	2.27	2.24
23	1-Dodecanol	C ₁₂ H ₂₆ O	1.1	1.3	0.95	0.98	0.8	0.86	1.0	1.04
24	1-Hexadecanol	C ₁₆ H ₃₄ O	1.1	1.3	1.0	1.05	0.8	0.9	0.95	1.05
25	E-14-Hexadecanal	C ₁₆ H ₃₀ O	1.5	1.6	1.6	1.55	1.75	1.7	1.6	1.55

Table 10. Composition of functional groups in bio-oil available produced by catalytic pyrolysis

Functional Group (wt%)	Z 1:5	Z 1:10	Co/Z 1:5	Co/Z 1:10	Ni/Z 1:5	Ni/Z 1:10	Mo/Z 1:5	Mo/Z 1:10
Alkanes/Alkenes	26.35	25.4	26.46	26.46	29.95	28.88	27.72	27.44
Aromatic compounds	6.0	5.4	5.95	5.4	6.64	5.55	6.25	5.15
Oxygenated compounds	5.9	6.35	5.85	5.84	5.75	5.79	5.82	5.88
Nitrogenated compounds	17.95	17.45	18.96	17.99	20.19	18.71	17.48	16.49
Phenolic compounds	8.0	6.9	10.95	9.83	10.19	9.39	10.75	9.85

The highest percentage of alkane/alkene compounds with 29.95% was related to bio-oil produced with zeolite-based nickel catalyst (Ni/HZSM-5) with a ratio of 1:5. At the same time, the highest amount of pollutant compounds (aromatic, nitrogenous and phenolic compounds) with 37.02% was related to it. The content of oxygenated compounds with 5.75% had the lowest amount of pollutant compounds related to bio-oil produced zeolite catalyst with a ratio of 1:5. Therefore, the bio-oil obtained from biomass catalytic pyrolysis using zeolite-based nickel catalyst (Ni/HZSM-5) with a ratio of 1:5 has the highest heat value and pollution and bio-oil obtained with zeolite catalyst has the lowest heat value and pollution in comparison with 1:10.

Comparison of Thermal and Catalytic Pyrolysis Results

In order to determine the optimal conditions, first, the experiments are carried out with thermal pyrolysis and without the presence of catalysts in the progress stages of the production process, the exact role and weight of the effect of the effective variables are determined, thus,

the variables and their effects are determined and by performing several tests, the optimum values of these variables including temperature 525 °C, flow rate of gas carrying 0.5 L/min and heating rate 20 °C /min, by producing the highest amount of bio-oil produced at 34.77 wt% and HHV of 29.2 MJ/kg were obtained. Then, catalytic pyrolysis experiments with the above conditions were carried out using catalysts prepared with different ratios, which produced in the highest amount of bio-oil production under these conditions with zeolite catalyst (HZSM-5) with 1:10 ratio at 18.51% and the highest heating value of produced bio-oil (HHV) Zeolite-based molybdenum catalyst (Mo/HZSM-5) was obtained at a ratio of 1:5, 39.44 MJ/kg. This result shows that although zeolite catalyst has the highest bio-oil production yield in catalytic pyrolysis, the highest heat value and energy recovery are molybdenum catalysts based on zeolite, because this can be achieved by carbon and oxygen percentages obtained from elemental analysis. The highest carbon content and the lowest amount of oxygen in bio-oil samples obtained from catalytic pyrolysis belong to zeolite-based molybdenum catalyst, and as mentioned earlier, increasing the percentage of carbon and decreasing the percentage of oxygen will increase the HHV.

The use of catalyst in optimization of bio-oil production resulted in 47.27% recovery energy and HHV increase of 285.91%. These results show the positive impact of catalyst clearly (Table 11).

Table 11. Initial comparison of bio-oil produced from thermal pyrolysis and catalytic pyrolysis produced from sewage sludge

Sample	(HHV) (MJ/kg)	(RE) (%)	Yield (%)
Sewage sludge	10.22	-	-
Thermal pyrolysis bio-oil	29.2	185.71	32.84
Catalytic pyrolysis bio-oil	39.44	35.07	48.69

As can be seen in Fig.10, catalyst usage increased alkane/alkene compounds by 5.76% and aromatic compounds by 3.47%, but decreased oxygenated compounds by 12.46%, 1.45% nitrogenous compounds and 6.09% phenolic compounds. Therefore, increasing the percentage of alkane/alkene compounds and decreasing the percentage of oxygenated compounds increase the HHV.

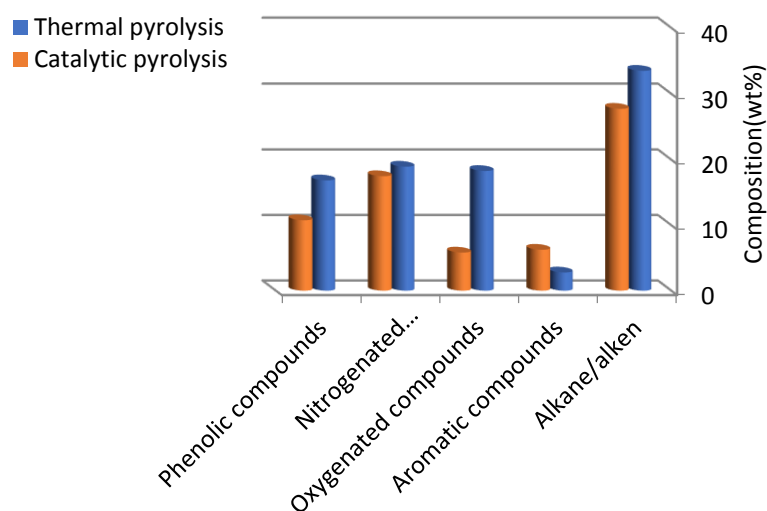

Fig.10. Comparison of the functional groups in bio-oil produced by thermal and catalytic pyrolysis

Conclusion

Since urban sewage sludge is a stable and suitable source of organic matter, extensive research has been done in recent years for the economic and cost-effective production of bio-oil from it. Pyrolysis experiments were performed in two stages without and with catalyst. In the condition without catalyst, the highest yield of bio-oil production was obtained as 32.84 wt% at 525 °C, heating rate 20 °C/min and gas flow rate 0.5 L/min. Catalytic pyrolysis experiments in optimal conditions of non-catalytic pyrolysis with four zeolite catalysts (HZSM-5), zeolite-based nickel (Ni/HZSM-5), zeolite-based cobalt (Co/HZSM-5) and zeolite-based molybdenum (Mo/HZSM-5) was done with catalyst to zeolite ratios of 1:5 and 1:10, and the highest yield of bio-oil produced using zeolite catalyst with a ratio of 1:10 is 18.51%. Also, among the catalysts, the highest bio-oil production yield belongs to molybdenum metal based on zeolite with a ratio of 1:10 and a value of 16.48%. The highest heat value of biofuel produced with 39.44 MJ/kg with a production yield of 47.27% was obtained with molybdenum catalyst based on zeolite (Mo/HZSM-5). The highest cetane number related to bio-petroleum produced with Mo/HZSM-5 catalyst is 68.4, which is 43.12% more than the standard minimum of diesel fuels. The lowest iodine number is 119.2, which corresponds to the Mo/HZSM-5 catalyst. Its density and kinematic viscosity are also within the standard range. Therefore, bio-petroleum obtained from catalytic pyrolysis of sewage sludge is a very suitable fuel for use in diesel engines.

The results of the studies clearly show that the bio-oil produced in this research can compete with other similar fuels in all aspects and a suitable alternative for them in the near future, of course, it is also necessary to mention that the production of bio-oil from municipal sewage sludge using pyrolysis on an industrial and commercial scale still requires more research. It seems that the zeolite catalyst is not very suitable for the removal of nitrogenous compounds and the nitrogen removal efficiency is negligible. It is suggested to use processes such as ultrasonic pretreatment, acid washing and hydrothermal liquefaction before the pyrolysis process to reduce the amount of nitrogen. Removing compounds containing nitrogen, oxygen and sulfur from bio-oil, as well as adjusting its viscosity in a practical and economical way, is one of the most important research efforts in the future.

Nomenclature

APD (nm)	Average particle diameter
BET	Brunauer Emmett Teller
DTG	Derivative thermogravimetry
ER (%)	Energy recovery
FT-IR	Fourier Transform Infrared Spectroscopy
GC-MS	Gas Chromatography Mass Spectrometry
H (°C/min)	Heating rate
HHV (MJ/kg)	High heat value
Q (mL/min)	Gas flow rate
SAR	Silicon to Aluminium ratio
SBR	Sequence batch reactor
SEM	Scanning electron microscopy
Sp (m ² /g)	Specific particle area
T (°C)	Temperature
TGA	Thermogravimetry
V _p (m ³ /g)	Volume of particle
XRD	X-ray diffraction
°A	Angstrom

References

- [1] Energy, I. and C. Change, World Energy Outlook Special Report. 2015 IEA: Paris, France.
- [2] Davie T. Fundamentals of hydrology. Routledge; 2019 Apr 23. <https://doi.org/10.4324/9780203798942>.
- [3] Lu H, Zhang W, Wang S, Zhuang L, Yang Y, Qiu R. Characterization of sewage sludge-derived biochars from different feedstocks and pyrolysis temperatures. *Journal of Analytical and Applied Pyrolysis*. 2013 Jul 1;102:137-43. <https://doi.org/10.1016/j.jaap.2013.03.004>.
- [4] Zhang L, Xu C, Champagne P, Mabee W. Overview of current biological and thermochemical treatment technologies for sustainable sludge management. *Waste management & research*. 2014 Jul;32(7):586-600.
- [5] Yoshida H, Christensen TH, Scheutz C. Life cycle assessment of sewage sludge management: a review. *Waste Management & Research*. 2013 Nov;31(11):1083-101. <https://doi.org/10.1177%2F0734242X13504446>.
- [6] Fonts I, Azuara M, Gea G, Murillo MB. Study of the pyrolysis liquids obtained from different sewage sludge. *Journal of analytical and applied pyrolysis*. 2009 May 1;85(1-2):184-91. <https://doi.org/10.1016/j.jaap.2008.11.003>.
- [7] Chan WP, Wang JY. Comprehensive characterisation of sewage sludge for thermochemical conversion processes—based on Singapore survey. *Waste management*. 2016 Aug 1;54:131-42. <https://doi.org/10.1016/j.wasman.2016.04.038>.
- [8] Alvarez J, Amutio M, Lopez G, Barbarias I, Bilbao J, Olazar M. Sewage sludge valorization by flash pyrolysis in a conical spouted bed reactor. *Chemical Engineering Journal*. 2015 Aug 1;273:173-83. <https://doi.org/10.1016/j.cej.2015.03.047>.
- [9] Li M, Xiao B, Wang X, Liu J. Consequences of sludge composition on combustion performance derived from thermogravimetry analysis. *Waste Management*. 2015 Jan 1;35:141-7. <https://doi.org/10.1016/j.wasman.2014.10.004>.
- [10] Magdziarz A, Werle S. Analysis of the combustion and pyrolysis of dried sewage sludge by TGA and MS. *Waste management*. 2014 Jan 1;34(1):174-9. <https://doi.org/10.1016/j.wasman.2013.10.033>.
- [11] Nowicki L, Ledakowicz S. Comprehensive characterization of thermal decomposition of sewage sludge by TG–MS. *Journal of analytical and applied pyrolysis*. 2014 Nov 1;110:220-8.
- [12] Gao N, Li J, Qi B, Li A, Duan Y, Wang Z. Thermal analysis and products distribution of dried sewage sludge pyrolysis. *Journal of Analytical and Applied Pyrolysis*. 2014 Jan 1;105:43-8. <https://doi.org/10.1016/j.jaap.2013.10.002>.
- [13] Shao J, Yan R, Chen H, Wang B, Lee DH, Liang DT. Pyrolysis characteristics and kinetics of sewage sludge by thermogravimetry Fourier transform infrared analysis. *Energy & Fuels*. 2008 Jan 16;22(1):38-45. <https://doi.org/10.1021/ef700287p>.
- [14] Font R, Fullana A, Conesa JA, Llavador F. Analysis of the pyrolysis and combustion of different sewage sludges by TG. *Journal of Analytical and Applied Pyrolysis*. 2001 Apr 1;58:927-41. [https://doi.org/10.1016/S0165-2370\(00\)00146-7](https://doi.org/10.1016/S0165-2370(00)00146-7).
- [15] Conesa JA, Marcilla A, Moral R, Moreno-Caselles J, Perez-Espinosa A. Evolution of gases in the primary pyrolysis of different sewage sludges. *Thermochimica Acta*. 1998 Mar 30;313(1):63-73.
- [16] Conesa JA, Marcilla A, Prats D, Rodriguez-Pastor M. Kinetic study of the pyrolysis of sewage sludge. *Waste Management & Research*. 1997 Jun 1;15(3):293-305. <https://doi.org/10.1006/wmre.1996.0085>.
- [17] Urban DL, Antal Jr MJ. Study of the kinetics of sewage sludge pyrolysis using DSC and TGA. *Fuel*. 1982 Sep 1;61(9):799-806. [https://doi.org/10.1016/0016-2361\(82\)90306-4](https://doi.org/10.1016/0016-2361(82)90306-4).
- [18] Fonts I, Gea G, Azuara M, Ábrego J, Arauzo J. Sewage sludge pyrolysis for liquid production: a review. *Renewable and sustainable energy reviews*. 2012 Jun 1;16(5):2781-805. <https://doi.org/10.1016/j.rser.2012.02.070>.

- [19] Biomass pyrolysis, C.B.C., Senior Research Associate, Energy Institute, The Pennsylvania State University.
- [20] Maguyon MC, Capareda SC. Evaluating the effects of temperature on pressurized pyrolysis of *Nannochloropsis oculata* based on products yields and characteristics. *Energy Conversion and Management*. 2013 Dec 1;76:764-73. <https://doi.org/10.1016/j.enconman.2013.08.033>.
- [21] Dai Q, Jiang X, Jiang Y, Jin Y, Wang F, Chi Y, Yan J. Formation of PAHs during the pyrolysis of dry sewage sludge. *Fuel*. 2014 Aug 15;130:92-9. <https://doi.org/10.1016/j.fuel.2014.04.017>.
- [22] Yu Y, Yu J, Sun B, Yan Z. Influence of catalyst types on the microwave-induced pyrolysis of sewage sludge. *Journal of Analytical and Applied Pyrolysis*. 2014 Mar 1;106:86-91. <https://doi.org/10.1016/j.jaap.2014.01.003>.
- [23] The research progress of biomass pyrolysis processes, w.f.o.d.t.E.t.e.a.h. <https://doi.org/10.1016/j.apenergy.2017.08.105>.
- [24] Suopajarvi H, Pongrácz E, Fabritius T. The potential of using biomass-based reducing agents in the blast furnace: A review of thermochemical conversion technologies and assessments related to sustainability. *Renewable and Sustainable Energy Reviews*. 2013 Sep 1;25:511-28. <https://doi.org/10.1016/j.rser.2013.05.005>.
- [25] Czajczyńska D, Anguilano L, Ghazal H, Krzyżyńska R, Reynolds AJ, Spencer N, Jouhara H. Potential of pyrolysis processes in the waste management sector. *Thermal science and engineering progress*. 2017 Sep 1;3:171-97. <https://doi.org/10.1016/j.tsep.2017.06.003>.
- [26] Azizi K, Moraveji MK, Najafabadi HA. A review on bio-fuel production from microalgal biomass by using pyrolysis method. *Renewable and Sustainable Energy Reviews*. 2018 Feb 1;82:3046-59. <https://doi.org/10.1016/j.rser.2017.10.033>.
- [27] Cheng F, Cui Z, Chen L, Jarvis J, Paz N, Schaub T, Nirmalakhandan N, Brewer CE. Hydrothermal liquefaction of high-and low-lipid algae: Bio-crude oil chemistry. *Applied Energy*. 2017 Nov 15;206:278-92.
- [28] Fuentes-Cano D, Gómez-Barea A, Nilsson S, Ollero P. The influence of temperature and steam on the yields of tar and light hydrocarbon compounds during devolatilization of dried sewage sludge in a fluidized bed. *Fuel*. 2013 Jun 1;108:341-50. <https://doi.org/10.1016/j.fuel.2013.01.022>.
- [29] Demirbas A. Effects of temperature and particle size on bio-char yield from pyrolysis of agricultural residues. *Journal of analytical and applied pyrolysis*. 2004 Nov 1;72(2):243-8. <https://doi.org/10.1016/j.jaap.2004.07.003>.
- [30] Antal MJ, Grønli M. The art, science, and technology of charcoal production. *Industrial & engineering chemistry research*. 2003 Apr 16;42(8):1619-40. <https://doi.org/10.1021/ie0207919>.
- [31] Belotti G, de Caprariis B, De Filippis P, Scarsella M, Verdone N. Effect of *Chlorella vulgaris* growing conditions on bio-oil production via fast pyrolysis. *Biomass and Bioenergy*. 2014 Feb 1;61:187-95. <https://doi.org/10.1016/j.biombioe.2013.12.011>.
- [32] Tripathi M, Sahu JN, Ganesan P. Effect of process parameters on production of biochar from biomass waste through pyrolysis: A review. *Renewable and sustainable energy reviews*. 2016 Mar 1;55:467-81. <https://doi.org/10.1016/j.rser.2015.10.122>.
- [33] Zainan NH, Srivatsa SC, Bhattacharya S. Catalytic pyrolysis of microalgae *Tetraselmis suecica* and characterization study using in situ Synchrotron-based Infrared Microscopy. *Fuel*. 2015 Dec 1;161:345-54. <https://doi.org/10.1016/j.fuel.2015.08.030>.
- [34] Park HJ, Heo HS, Park YK, Yim JH, Jeon JK, Park J, Ryu C, Kim SS. Clean bio-oil production from fast pyrolysis of sewage sludge: effects of reaction conditions and metal oxide catalysts. *Bioresource technology*. 2010 Jan 1;101(1):S83-5.
- [35] Fonts I, Juan A, Gea G, Murillo MB, Sánchez JL. Sewage sludge pyrolysis in fluidized bed, 1: influence of operational conditions on the product distribution. *Industrial & Engineering Chemistry Research*. 2008 Aug 6;47(15):5376-85. <https://doi.org/10.1021/ie7017788>.
- [36] Shen L, Zhang DK. An experimental study of oil recovery from sewage sludge by low-temperature pyrolysis in a fluidised-bed☆. *Fuel*. 2003 Mar 1;82(4):465-72. [https://doi.org/10.1016/S0016-2361\(02\)00294-6](https://doi.org/10.1016/S0016-2361(02)00294-6).

- [37] Inguanzo M, Dominguez A, Menéndez JA, Blanco CG, Pis JJ. On the pyrolysis of sewage sludge: the influence of pyrolysis conditions on solid, liquid and gas fractions. *Journal of Analytical and Applied Pyrolysis*. 2002 Mar 1;63(1):209-22. [https://doi.org/10.1016/S0165-2370\(01\)00155-3](https://doi.org/10.1016/S0165-2370(01)00155-3).
- [38] Stammbach MR, Kraaz B, Hagenbucher R, Richarz W. Pyrolysis of sewage sludge in a fluidized bed. *Energy & fuels*. 1989 Mar 1;3(2):255-9.
- [39] Khosravanipour Mostafazadeh A, Solomatnikova O, Drogui P, Tyagi RD. A review of recent research and developments in fast pyrolysis and bio-oil upgrading. *Biomass Conversion and Biorefinery*. 2018 Sep;8:739-73. <https://doi.org/10.1007/s13399-018-0320-z>.
- [40] Zeng Y, Zhao B, Zhu L, Tong D, Hu C. Catalytic pyrolysis of natural algae from water blooms over nickel phosphide for high quality bio-oil production. *RSC advances*. 2013;3(27):10806-16. <http://dx.doi.org/10.1039/C3RA23453C>.
- [41] Anand V, Sunjeev V, Vinu R. Catalytic fast pyrolysis of *Arthrospira platensis* (spirulina) algae using zeolites. *Journal of Analytical and Applied Pyrolysis*. 2016 Mar 1;118:298-307. <https://doi.org/10.1016/j.jaap.2016.02.013>.
- [42] Payormhorm J, Kangvansaichol K, Reubroycharoen P, Kuchonthara P, Hinchiranan N. Pt/Al₂O₃-catalytic deoxygenation for upgrading of *Leucaena leucocephala*-pyrolysis oil. *Bioresource technology*. 2013 Jul 1;139:128-35. <https://doi.org/10.1016/j.biortech.2013.04.023>.
- [43] Le TA, Ly HV, Kim J. Catalytic pyrolysis of alga *Saccharina japonica* using Co/ γ -Al₂O₃ and Ni/ γ -Al₂O₃ catalyst. *Energy Sources, Part A: Recovery, Utilization, and Environmental Effects*. 2014 Nov 2;36(21):2392-400. <https://doi.org/10.1080/15567036.2013.839763>.
- [44] Aysu T, Feroso J, Sanna A. Ceria on alumina support for catalytic pyrolysis of *Pavlova* sp. microalgae to high-quality bio-oils. *Journal of energy chemistry*. 2018 May 1;27(3):874-82. <https://doi.org/10.1016/j.jechem.2017.06.014>.
- [45] Aysu T, Maroto-Valer MM, Sanna A. Ceria promoted deoxygenation and denitrogenation of *Thalassiosira weissflogii* and its model compounds by catalytic in-situ pyrolysis. *Bioresource Technology*. 2016 May 1;208:140-8. <https://doi.org/10.1016/j.biortech.2016.02.050>.
- [46] Aysu T, Sanna A. Nannochloropsis algae pyrolysis with ceria-based catalysts for production of high-quality bio-oils. *Bioresource technology*. 2015 Oct 1;194:108-16. <https://doi.org/10.1016/j.biortech.2015.07.027>.
- [47] Arazo RO, de Luna MD, Capareda SC. Assessing biodiesel production from sewage sludge-derived bio-oil. *Biocatalysis and agricultural biotechnology*. 2017 Apr 1;10:189-96. <https://doi.org/10.1016/j.bcab.2017.03.011>.
- [48] Folgueras MB, Alonso M, Díaz RM. Influence of sewage sludge treatment on pyrolysis and combustion of dry sludge. *Energy*. 2013 Jun 15;55:426-35. <https://doi.org/10.1016/j.energy.2013.03.063>.
- [49] Angerbauer C, Siebenhofer M, Mittelbach M, Guebitz GM. Conversion of sewage sludge into lipids by *Lipomyces starkeyi* for biodiesel production. *Bioresource technology*. 2008 May 1;99(8):3051-6. <https://doi.org/10.1016/j.biortech.2007.06.045>.
- [50] Rover MR, Hall PH, Johnston PA, Smith RG, Brown RC. Stabilization of bio-oils using low temperature, low pressure hydrogenation. *Fuel*. 2015 Aug 1;153:224-30. <https://doi.org/10.1016/j.fuel.2015.02.054>.
- [51] Yang J, Blanchette D, De Caumia B, Roy C. Modelling, scale-up and demonstration of a vacuum pyrolysis reactor. *Progress in thermochemical biomass conversion*. 2001 Jun 13;2:1296-311. <https://doi.org/10.1002/9780470694954.ch107>.
- [52] Moazezi MR, Bayat H, Tavakoli O, Hallajisani A. Hydrothermal liquefaction of *Chlorella vulgaris* and catalytic upgrading of product: Effect of process parameter on bio-oil yield and thermodynamics modeling. *Fuel*. 2022 Jun 15;318:123595. <https://doi.org/10.1016/j.fuel.2022.123595>.

- [53] Biswas B, Singh R, Krishna BB, Kumar J, Bhaskar T. Pyrolysis of azolla, sargassum tenerrimum and water hyacinth for production of bio-oil. *Bioresource Technology*. 2017 Oct 1;242:139-45. <https://doi.org/10.1016/j.biortech.2017.03.044>.
- [54] Verlicchi P, Zambello EJ. Pharmaceuticals and personal care products in untreated and treated sewage sludge: Occurrence and environmental risk in the case of application on soil—A critical review. *Science of the Total Environment*. 2015 Dec 15;538:750-67. <https://doi.org/10.1016/j.scitotenv.2015.08.108>.
- [55] Babich IV, Van der Hulst M, Lefferts L, Moulijn JA, O'Connor P, Seshan K. Catalytic pyrolysis of microalgae to high-quality liquid bio-fuels. *Biomass and Bioenergy*. 2011 Jul 1;35(7):3199-207. <https://doi.org/10.1016/j.biombioe.2011.04.043>.
- [56] McLaren J. Sugarcane as a Feedstock for Biofuels. of An Analytical White Paper, prepared for the National Cane Growers Association, by StrathKirn Inc. <http://www.ncga.com/file/541>. 2009:11. <https://doi.org/10.1016/j.biortech.2009.06.103>.
- [57] Ma C, Geng J, Zhang D, Ning X. Non-catalytic and catalytic pyrolysis of *Ulva prolifera* macroalgae for production of quality bio-oil. *Journal of the Energy Institute*. 2020 Feb 1;93(1):303-11. <https://doi.org/10.1016/j.joei.2019.03.001>.
- [58] Xie Q, Addy M, Liu S, Zhang B, Cheng Y, Wan Y, Li Y, Liu Y, Lin X, Chen P, Ruan R. Fast microwave-assisted catalytic co-pyrolysis of microalgae and scum for bio-oil production. *Fuel*. 2015 Nov 15;160:577-82. <https://doi.org/10.1016/j.fuel.2015.08.020>.
- [59] Feng H, Zhang B, He Z, Wang S, Salih O, Wang Q. Study on co-liquefaction of *Spirulina* and *Spartina alterniflora* in ethanol-water co-solvent for bio-oil. *Energy*. 2018 Jul 15;155:1093-101. <https://doi.org/10.1016/j.energy.2018.02.146>.
- [60] Di Blasi C. Modeling chemical and physical processes of wood and biomass pyrolysis. *Progress in energy and combustion science*. 2008 Feb 1;34(1):47-90. <https://doi.org/10.1016/j.pecs.2006.12.001>.
- [61] Scott DS, Piskorz J. The flash pyrolysis of aspen- poplar wood. *The Canadian Journal of Chemical Engineering*. 1982 Oct;60(5):666-74. <https://doi.org/10.1002/cjce.5450600514>.
- [62] Dabros TM, Stummann MZ, Høj M, Jensen PA, Grunwaldt JD, Gabrielsen J, Mortensen PM, Jensen AD. Transportation fuels from biomass fast pyrolysis, catalytic hydrodeoxygenation, and catalytic fast hydrolysis. *Progress in Energy and Combustion Science*. 2018 Sep 1;68:268-309. <https://doi.org/10.1016/j.pecs.2018.05.002>.
- [63] Pourkarimi S, Hallajisani A, Alizadehdakhl A, Nouralishahi A. Biofuel production through micro- and macroalgae pyrolysis—A review of pyrolysis methods and process parameters. *Journal of Analytical and Applied Pyrolysis*. 2019 Sep 1; 142:104599. <https://doi.org/10.1016/j.jaap.2019.04.015>.

How to cite: Haghghat M, Majidian N, Hallajisani A, Samipourgiri M. Production and Optimization of Bio-Oil from Municipal Wastewater Sludge by Thermal and Catalytic Pyrolysis Process. *Journal of Chemical and Petroleum Engineering*. 2023; 57(2): 227-247.